

Billi™

User guide
Billi B-4000
Tap options XL, XT, XR
(914000)



User guide

Billi B-4000 – XL, XT, XR.

Contents

Warnings & Important information	2
General Maintenance	3
Features and Modes	4
Options & Operation	
XL Tap	5
XT, XR Tap	6
Dispenser Icon Codes	7
XL Tap	7
XT Tap	8
XR Tap	9
Filtration Information	10
Changing the filter	11
Service Support	12

Warnings & Important information

- For continued safety of this appliance it must be installed, operated and maintained in accordance with the manufacturer's instructions.
- Your appliance should be installed by a suitably qualified tradesperson.
- For correct operation of this appliance it is essential to observe the instructions as outlined in this booklet.
- Do not use this appliance with water that is microbiologically unsafe or with water of unknown quality without adequate disinfection before or after the system. Systems certified for cyst reduction may be used on disinfected water that may contain filterable cysts.
- Filter replacement must be performed at intervals of not more than 12 months.
- Use this appliance only as directed in these instructions and only for its designed purpose.

- This appliance is not intended for use by persons (including children) with reduced physical, sensory or mental capabilities, or lack of experience and knowledge, unless they have been given supervision or instruction concerning use of the appliance by a person responsible for their safety.
- This appliance is not suitable in an area where a water jet could be used.
- Children should be supervised to ensure that they do not play with the appliance.
- **DANGER:** The operation of the thermal cut-out indicates a possibly dangerous situation. Do not reset the thermal cut-out until the water heater has been serviced by a suitably qualified person.
- **WARNING:** Do not connect any restrictor or pressure relief device to the vent pipe of this water heater if installed.
- **WARNING:** When positioning the appliance, ensure the supply cord is not trapped or damaged.
- **WARNING:** Do not locate multiple portable socket - outlets or portable power supplies at the rear of the appliance.
- **WARNING:** Avoid spillage on the connector.
- **WARNING:** Potential injury from misuse.
- **WARNING:** Heating element surface is subject to residual heat after use.

User guide

Billi B-4000 – XL, XT, XR.

- If the supply cord is damaged, it must be replaced by the manufacturer, its service agent or similarly qualified persons in order to avoid creation of a hazard.
- Billi hose sets as supplied with the appliance are to be used. Old or other manufacturer's hose sets should not be re-used.
- If the appliance is located where the ambient air temperature could fall below 4°C when the heater is not in use, do not turn off the power supply to the appliance. This safeguard does not offer the same protection to the connecting pipework and fittings.
- The ambient temperatures this unit should operate within are 4°C to 45°C.
- Turn off power to unit, by unplugging the power cord from the power point, if water supply is turned off.
- The appliance is intended to be used in household and similar application such as:
 - Staff kitchen areas in shops, offices and other working environments
 - Farm houses and by clients in hotels, motels and other residential type environments
 - Bed and breakfast type environments
 - Catering and similar non-retail applications

Please note maximum water inlet pressure is 1MPa

Cupboard ventilation requirements

Your Billi B-4000 underbench module requires no cupboard ventilation but requires air space around the unit of 25mm. Care should be taken when using the cupboard space, to avoid stretching or damaging plastic pipe work. Check fittings and tubing at each filter change for signs of damage or leakage. Always ensure access to power switch and water supply tap is not restricted.

Caution and safety

Boiling water is dangerous and can cause severe burns, particularly with young children. Boiling water must always be handled with caution. Use this appliance only as directed in these instructions and only for the purpose for which it has been designed. Your Billi B-4000 is designed to be safe and practical. In an environment with young children, it is recommended that the boiling water safety switch is activated.

The following safety features have been included:

- Ergonomic levers
- Levers/touch activations located safely above water outlet.
- Smooth electronically controlled boiling water flow rate. Flow is briefly reduced as water first enters cup to prevent splashing.
- Dispenser remains cool to touch.
- Childproof safety switch.
- Boiling water Safety Isolation mode.

General Maintenance

Your Billi B-4000 has been designed to require minimal maintenance other than replacement of filter cartridges. During each filter change, check all water connection fittings for signs of leakage. Check all tubing for any signs of damage. Check the cupboard area around the base of unit for any signs of moisture. Ensure side vents of the under bench module are kept clear and airflow is not obstructed. Restricted airflow will cause inefficient operation of the refrigeration system.

—Cleaning the dispenser

Your Billi B-4000 Dispenser is fabricated from robust metal with a tough protect chrome plating. Care of dispenser is as with any chrome plated tapware. Avoid using abrasive cleaners. Wipe clean using a damp cloth. Use of a non-solvent, non-smearing cleaner such as Windex is recommended. Do not pour water over dispenser.

User guide

Billi B-4000 – XL, XT, XR.

Features and Modes

—Dispenser Swivel

The B-4000 dispenser incorporates a swivel function, allowing the dispenser to be swung out of the way if more sink space is required. A central position stop provides positive location during normal usage.

—Safety timeout

The Billi B-4000 incorporates a water delivery Safety Timeout to prevent an uncontrolled flow of water. Water flow stops automatically after a set time interval. Flow can be started again by releasing and pressing the dispenser lever or for the XT or XR option simply press either the red or blue button.

Boiling water timeout – 10 secs.

—Childproof safety switch

The Billi B-4000 is fitted with a childproof safety lock-out feature to protect against accidental dispensing of boiling water and the risk of burns. Please refer to page 5.

—Standby mode

Standby operation may be optionally enabled to reduce power consumption. In standby mode the hot water set point is reduced to 72°C and the cold water set point is increased to 18°C. When enabled, standby is invoked after two hours from the time of last use. When a tap lever is pressed in standby no water is dispensed. The indicators will flash to indicate the water is not ready. The tap can be repressed to dispense water. During Standby mode the Moon & Star icons will flash, to activate, refer to Options, page 5.

—Boiling water disabled mode

Your Billi B-4000 features an additional boiling water safety isolation feature. Once activated, delivery of boiling water becomes totally disabled. Chilled water can be dispensed normally.

During this mode, the hot – red – icon will remain off. To activate, refer to Options & Operation, Safety Switch Settings on page 5.

—Holiday mode

Holiday Mode is provided to save energy when the unit will not be used for long periods. In this mode both the water chiller and water heater are disabled and the unit will use very little power. Pressing the Pressure Relief button places the unit in Holiday Mode. The unit will exit Holiday Mode if either the power is turned off then on or if any of the tap levers are pressed. The Self Learning Timer will ignore user behaviour while the unit is in Holiday Mode and resume normal operation when the mode is terminated. Holiday Mode is indicated the moon and star icon, see page 6 for icon codes.

User guide

Billi B-4000 – XL.

Options & Operation

To operate, simply press the left lever to dispense boiling water and the right lever to dispense ambient. When lifted the levers will latch for continual delivery, until released with a light press.

Operating modes can be selected by the user by entering Options Mode.

Within the options mode, you can set the safety switch through the hot water lever and power save mode through the cold water lever.

See below for further instructions.

—To enter the options mode:

1. Turn on the unit and wait for normal operation (icons are both illuminated constantly).
2. Press both the hot and cold levers on the dispenser. While holding the two levers down, touch the safety switch indent at the back of the dispenser. Hold both levers and the safety switch until dispenser lights change colour.
3. Release both the levers & safety switch
4. Within 10 seconds, push and release the pressure relief button on the unit.
Note: Older models may require this step to be skipped.
5. Unit is now in options mode.
6. If you wish to change or set the safety switch mode, follow the safety switch settings procedure. If you wish to change or activate the power saving mode follow the power save mode settings procedure.

—Safety Switch settings

The **Red** padlock indicates the different safety settings enabled. To change or activate a setting once in options mode, press and release the hot (left) lever to scroll through the following options;

- **Red Icon Off:** indicates the hot tap is disabled.
- **Padlock icon on, Red icon on:** indicates hot tap safety switch is enabled
- **Red Icon On:** indicates normal operation with safety switch not enabled.

To save new setting and exit Options Mode, touch the safety switch and release. Wait 10 seconds for unit to return to normal operation with modified settings.

—Power save mode settings (EcoIntelligence, standby or on 24/7)

The **Green** icons on the tap indicates the power save level that is selected. To change or activate a setting once in options mode, press and release the ambient (right) lever to scroll through the following options;

- **Green leaf on:** indicates Eco Intelligence™ self learning timer is enabled.
- **Green moon & stars icon flashing:** indicates Standby Mode is enabled.
- **White Icon On:** indicates system is in 24 hour continuous mode.

To save new setting and exit Options Mode, press the safety switch and release. Wait 10 seconds for unit to return to normal operation with now settings.

—Holiday mode

To set press the pressure relief valve located under the unit cover beside the filter housing.

User guide

Billi B-4000 – XT, XR.

Options & Operation

To operate, simply press the red (left) button to dispense boiling water, and blue (right) button ring to dispense ambient filtered water.

When the red or blue buttons are double tapped, the water will dispense continually until interrupted by another light press of either button.

Operating modes can be selected by the user by entering option mode. Within the options mode, you can set the safety switch through the hot red button (left) and power save mode through the blue button (right).

—To enter the options mode:

1. Turn on the unit and wait for normal operation (red and blue rings are both illuminated constantly).
2. Press both the hot and cold rings on the dispenser. While holding the two rings down, touch the padlock icon. Hold both rings and the padlock until dispenser rings change colour.
3. Release both the rings & safety switch
4. Within 10 seconds, push and release the pressure relief button on the unit.
Note: Older models may require this step to be skipped.
5. Unit is now in options mode.
6. If you wish to change or set the safety switch mode, follow the safety switch settings procedure. If you wish to change or activate the power saving mode follow the power save mode settings procedure.

—Safety Switch settings

The **Red** padlock indicates the different safety settings enabled. To change or activate a setting once in options mode as above, press and release the red (left) button to scroll through the following options;

- **Red Icon Off:** indicates the hot tap is disabled.
- **Padlock icon on, Red icon on:** indicates hot tap safety switch is enabled
- **Red Icon On:** indicates normal operation with safety switch not enabled.

To save new setting and exit Options Mode, touch the safety switch and release. Wait 10 seconds for unit to return to normal operation with the desired settings.

To dispense boiling water once the safety switch is activated simply touch the red lock icon on top of the touch lens you will be able to dispense boiling water for 8 seconds. After 8 seconds the safety switch will automatically reactivate, and the red padlock icon will appear again.

—Power save mode settings (EcoIntelligence, standby or on 24/7)

The **Green** icons on the tap indicates the power save level that is selected. To change or activate a setting once in options mode, press and release the blue (right) button to scroll through the following options;

- **Green leaf icon on:** indicates Eco Intelligence™ self learning timer is enabled.
- **Moon & star icon on:** indicates Standby Mode is enabled.
- **Blue Icon On, no green icons:** indicates system is in 24 hour continuous mode.

To save new setting and exit Options Mode, press the safety switch and release. Wait 10 seconds for unit to return to normal operation with the desired settings.

—Holiday mode

To set press the pressure relief valve located under the unit cover beside the filter housing.

User guide

Billi B-4000 – XL.



Dispenser Icon

Orange dot.

Flashes when filter change due. On constant when overdue.

Red lock illuminated.

Safety button activated. To use, press the indent on the back of the tap momentarily & lift or press the boiling lever.

Green leaf illuminated.

Eco intelligence.

Green moon & stars illuminated.

In holiday mode or off.

Green moon & stars flashing

In standby mode.

Red dot.

















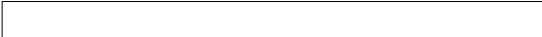

Flashes when heating up to temperature. On constant when boiling water ready. Off when in holiday, standby or boiling water disabled

Blue dot.

On constantly to indicate filtered water.

Red & Blue dots will flash yellow if the unit goes into fault.

Dispenser Icon codes

	Red		Normal operation
	Blue		Normal operation
	Red		Operating temperatures of hot and cold water not yet reached
	Blue		
	Red		Boiling water disabled
	Blue		
	Red		System in holiday or standby mode or off
	Blue		
	Orange		Unit in fault mode
	Orange		

User guide

Billi B-4000 – XT.



Dispenser Icon

Orange dot.

Flashes when filter change due. On constant when overdue.

Red lock illuminated.

Safety button activated. To use, press the indent on the top of the tap momentarily & lift or press the red button.

Green leaf illuminated.

Eco intelligence.

Green moon & stars illuminated.

In holiday mode or off.

Green moon & stars flashing

In standby mode.

Red ring.





















Flashes when heating up to temperature. On constant when boiling water ready. Off when in holiday, standby or boiling water disabled.

Blue ring.

On constantly to indicate filtered water.

Red & blue rings will flash yellow if the unit goes into fault.

Dispenser Icon codes

	Red		Normal operation
	Blue		Normal operation
	Red		Operating temperatures of hot and cold water not yet reached
	Blue		
	Red		Boiling water disabled
	Blue		
	Red		System in holiday or standby mode or off
	Blue		
	Orange		Unit in fault mode
	Orange		

User guide

Billi B-4000 – XR.



Dispenser Icon

Orange dot.

Flashes when filter change due. On constant when overdue.

Red lock illuminated.

Safety button activated. To use, press the indent on the top of the tap momentarily & press the boiling button (left).

Green leaf illuminated.

Eco intelligence.

Green moon & stars illuminated.

In holiday mode or off.

Green moon & stars flashing

In stand by mode.

Red ring.





















Flashes when heating up to temperature. On constant when boiling water ready. Off when in holiday, standby or boiling water disabled.

Blue ring.

On constantly to indicate filtered water.

Red & blue rings will flash yellow if the unit goes into fault.

Dispenser Icon codes

	Red		Normal operation
	Blue		Normal operation
	Red		Operating temperatures of hot and cold water not yet reached
	Blue		
	Red		Boiling water disabled
	Blue		
	Red		System in holiday or standby mode or off
	Blue		
	Orange		Unit in fault mode
	Orange		

User guide

Billi B-4000 – XL, XT, XR.

Billi Filter Cartridges

The Billi B-4000 features the Billi swing-change filtration system. The B-4000 is fitted with a single filter. The filters use Fibredyne™ technology which is fibrous and matted together, increasing the surface area of the carbon, meaning there is greater contact time and improved quality of filtration. It incorporates five stage filtration, removing sediment and chemical elements as well as enabling minerals to flow through the appliance without allowing scale build up and arresting the growth of bacterial microorganisms such as giardia and cryptosporidium. Use only genuine filters as designed for this system. All drinking water filtration systems should be flushed after a period of non-use.

Replacement of Billi Filter Cartridge

Periodic replacement of your Billi B-4000 Filter Cartridge is necessary to maintain the sparkling cleanliness and purity of your drinking water.

A replacement filter change service is available. To arrange, contact the Billi Service centre on 1800 812 321.

If you wish to install the replacement filter cartridges yourself, filters can be purchased online at www.billi.com.au or through a certified agent which will provide genuine Billi replacement filter cartridge sets.

Filter Change Due Monitor

The B-4000 filter change due monitor operates by counting the number of cups dispensed and the number of days elapsed until a pre-set level is reached. Once reached, the dispenser icons will briefly change to orange once every five seconds. The B-4000 will continue to operate while the filter indicator is flashing. Water filters installed in areas with higher levels of sediment will experience a reduced service life. It may be necessary to change filters before the change filter indicator flashes. If particularly dirty water is noticed coming through the water supply, e.g. from other tap ware, immediately place your Billi B-4000 into Holiday Mode by pressing the Pressure Relief button. This will help prevent premature blocking of the filter cartridges.

User guide

Billi B-4000 – XL, XT, XR.

Filter removal and replacement instructions

Important note: Please ensure you remove the foam packing under the filter before installing.

1. Remove the front panel.
2. Place the unit in Holiday Mode by pressing the Pressure Relief button once. The lights on the dispenser will alternate and then go off.
3. Hold filter and swing towards you slowly. The top of the filter is in a hinged cradle assembly. It should stop after approximately 30 degrees of travel.
4. The filter can now be released from the holding cradle by pulling down on the filter.
5. Take care not to spill water in the base of the tray. If so wipe gently with absorbent paper.
6. Install new filter into the same location by pushing all the way up into the cradle.
7. Push filter back into the unit until it locks into place. Power light should come back on.
8. Flush ambient water for 1 minute. Wait for 10 minutes. Flush ambient for an additional 1 minute.
9. Check for any leaks from around the filter, hosing or pipeworks.
10. Replace the front cover.

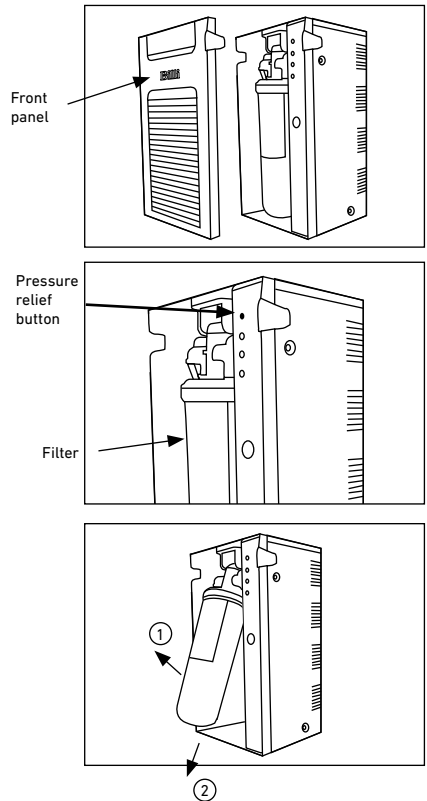

User guide

Billi B-4000 – XL, XT, XR.

Thank you for choosing to install a Billi B-4000 Drinking Water Appliance. Your B-4000 is manufactured to exacting standards using high quality materials and with proper maintenance and care, should function for many years.

For information on our filtration and service contract please contact Billi Head Office on 1800 812 321 or email us at service@billi.com.au.

For technical support please call 1800 812 321 and speak to one of Billi's experienced technician's.

To book a service call out request a filter change or please contact the Billi Service Centre on 1800 812 321 or book online at www.billi.com.au

Filter cartridges are also available for purchase online at www.billi.com.au

Billi™

Billi Australia Pty Ltd
42 Lucknow Crescent, Thomastown
Victoria 3074 Australia

Telephone 1800 812 321

www.billi.com.au

Designed and manufactured in Australia.

As Billi Australia Pty Ltd has a policy of continual improvement, all details are subject to change without notice. All goods are sold subject to our published terms and conditions. Billi is a registered trademark. 1220 612312 Rev02